



Safety Rope Switches from IDEM

Data Sheet Guardian Line Series



Heavy Duty Types: GLHD (Dual Head)
GLHD-SS (Dual Head)



GLHR/L (Single Head)
GLHR/L-SS (Single Head)



Standard Duty Types: GLS
GLS-SS



Mini Duty Type: GLM

Using Safety Rope Emergency Stop Switches

Application:

Safety Rope Emergency Stop Switches are mounted on machines and sections of plant conveyors which cannot be protected by guards. In contrast to traditional mushroom head type Emergency Stop buttons, Safety Rope Switches can initiate the emergency command from any point along the installed rope length.

In combination with any dual channel safety monitoring controllers IDEM Safety Rope Systems can be used as emergency stop devices and monitored for up to Category PLe/Cat.4 to ISO13849-1.

Operation:

All IDEM Safety Rope Emergency Stop Switches conform to European Standard ISO13850 (EN 418) and IEC60947-5-5. They have a positive mechanical linkage between the switch contacts and the wire rope as per IEC60947-5-1. The emergency stop switches are brought into the operational condition by pre-tensioning the rope by use of a tensioner/gripper device which clamps the rope and then hooks to the switch eyebolts. Correct tension can be observed by viewing the tension indicator on the switch housing. Once tensioned the switch contact blocks can be set to the operational condition (safety contacts closed, auxiliary contacts open) by pressing a blue reset button on the switch cover.

All of the Safety Rope Switches have wire-breakage monitoring. On pulling or breakage (tension loss) of the rope, the safety contacts are positively opened and the auxiliary contacts are closed. The switches are mechanically latched and can then only be returned to the operational condition by pressing the reset button as required by ISO13850 (EN418).

Installation Guide:

1. Installation of all IDEM Safety Rope Switch systems must be in accordance with a risk assessment for the individual application. Installation must only be carried out by competent personnel and in accordance with these instructions.
2. According to ISO13850 (EN418), pulleys may only be mounted such that a complete length of the rope can be observed.
3. Rope support eyebolts must be fitted at 2.5 m. min. to 3m. max. intervals along all rope lengths between switches. The rope must be supported no more than 500mm from the Switch eyebolt or Safety Spring (if used). It is important that this first 500mm is not used as part of the active protection coverage.
4. M5 mounting bolts must be used to fix the switches. Tightening torque for mounting bolts to ensure reliable fixing is 4 Nm. Tightening torque for the lid screws, conduit entry plugs and cable glands must be 1.5 Nm to ensure IP seal. Only use the correct size gland for the conduit entry and cable outside diameter.
5. Tensioning of rope is achieved by use of IDEM tensioner/gripper assemblies.

On installation set the tension to the mid position as indicated by the markers in the viewing window of each switch. Check operation of all switches and the control circuits by pulling the rope at various locations along the active protection area and resetting each switch by depressing the Blue Reset button. Ensure each time that the switches latch off and require manual resetting by depressing the blue reset button. Increase the system tension further, if required, depending upon the checks along the active length of coverage.

If fitted with a Mushroom type E-Stop button (Red) then test and reset each switch to ensure correct function of the safety control circuits.

Typical operational condition for successful operation of the system is less than 75N. pulling force and less than 150mm deflection of rope between eyebolt supports.

6. Maintenance:

- Every Week:* Check correct operation of system at locations along all coverage length.
Check for nominal tension setting, re-tension rope if necessary.
- Every 6 Months:* Isolate power and remove cover.
Check screw terminal tightness and check for signs of moisture ingress.

Never attempt to repair any switch.

Safety Rope Switches from IDEM

7. Recommended rope span options and fittings - (subject to an individual risk assessment for the installation):

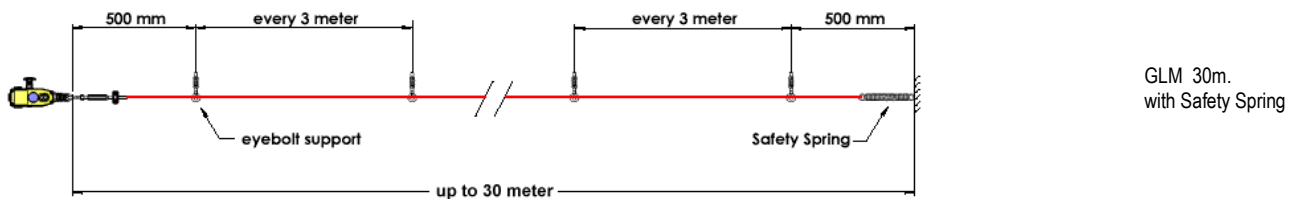

GLM 30m.
with Safety Spring

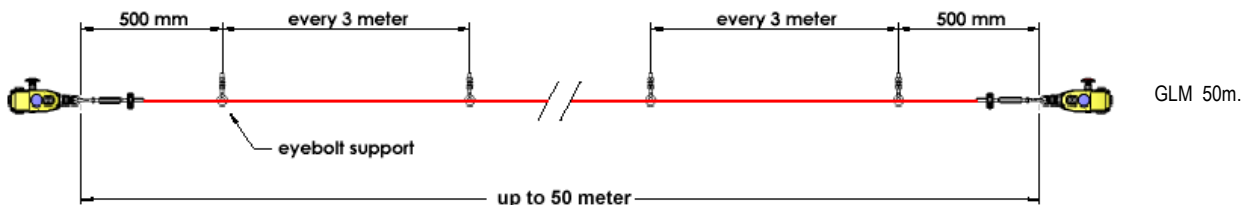

GLM 50m.

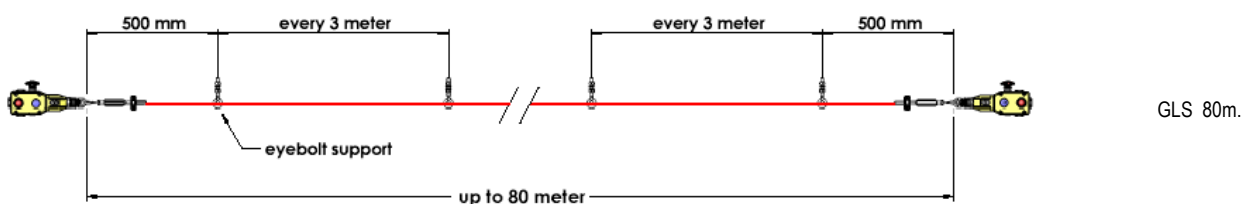

GLS 80m.

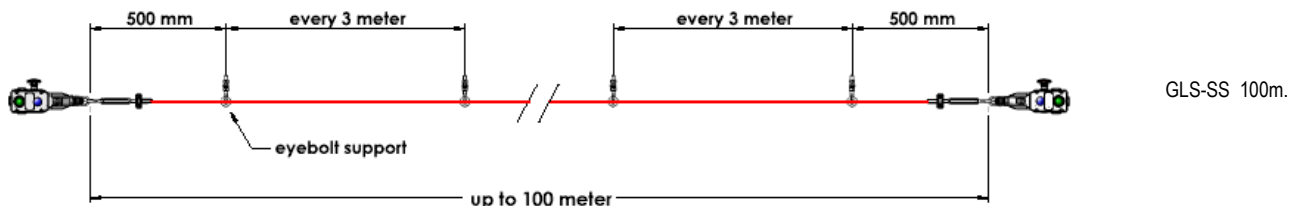

GLS-SS 100m.

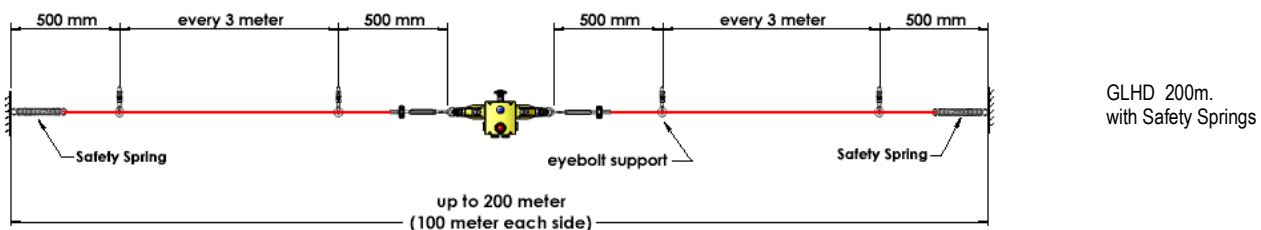

GLHD 200m.
with Safety Springs

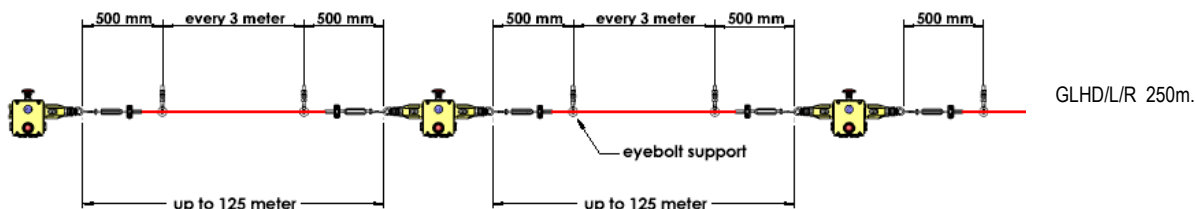

GLHD/L/R 250m.

Contact open
Contact closed

0mm 3.5mm 14.5mm 17.0mm

EX	2NC 1NO	3NC 1NO	2NC 2NO	4NC	4NC 2NO	Latched off – Rope Slack	Tension Range (Switch Reset)	Rope Pulled
NC	11/12	11/12	11/12	11/12	11/12			
	21/22	21/22	21/22	21/22	21/22			
		31/32		31/32	41/42			
NO	33/34	43/44	33/34	41/42	51/52			
			43/44		33/34			
					63/64			

Safety Rope Switches from IDEM

8. Wiring examples:

LED RED Flashing or Steady: Stopped
LED GREEN Steady: Run



When power is applied to the Red wire, the lamp will illuminate Red.
When power is applied to the Green Wire, the Lamp will illuminate Green.
Black is 0V.dc or Neutral for 110Vac and 230Vac versions.

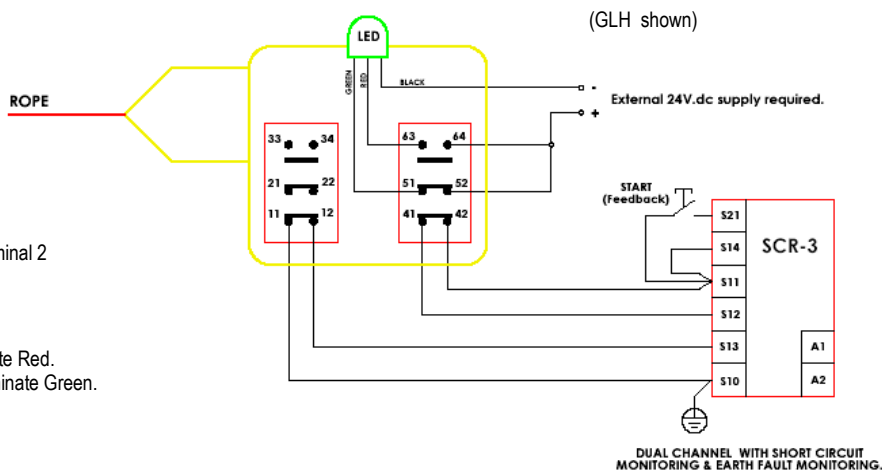

Wiring Circuits AS-i versions M12 Male Pin view from switch

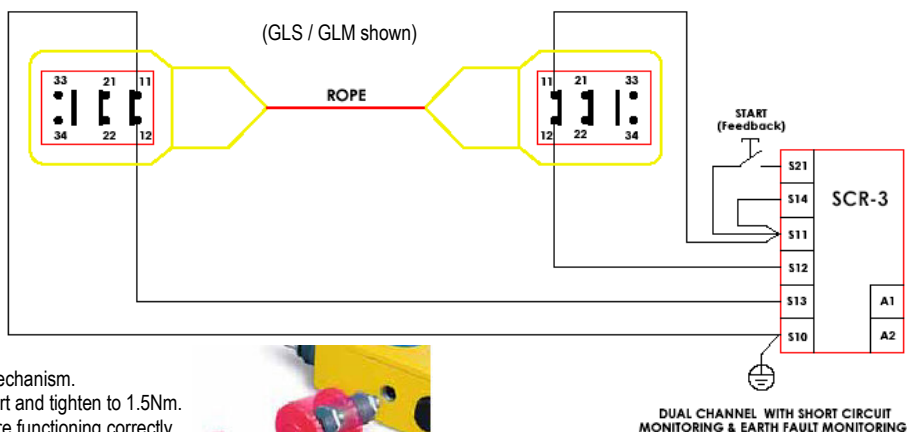
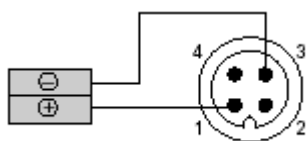

9. To fit Mushroom type Emergency stop Buttons:

- Remove M12 threaded plug from the mounting port.
- Apply thread locking solution to the threads of the E Stop mechanism.
- Insert the Emergency Stop Mechanism into the mounting port and tighten to 1.5Nm.
- After installation test and reset to ensure all safety circuits are functioning correctly.



10. Technical Specifications

Standards:	IEC 60947-5- IEC60947-5-5 UL508 ISO13850 IEC 13849-1 cULus TUV
Approvals:	
Mechanical Features:	
Enclosure / Cover	Die-Cast – Painted Yellow
External Parts	Stainless Steel
IP Rating	IP67
Rope Spans	Dual Head 250m.
Rope Tension device	IDEM Tensioner / Gripper – Quick Fixing
Rope Type:	4.0mm Outside Dia. Steel inner-PVC sheath
Mounting	4 x M5
Mounting position	
Conduit entries	4 x M20 or 4 x 1/2" NPT by part number
Torque settings	Mounting M5 4.0 Nm Lid T20 Torx M4 1.5 Nm Terminals 1.0 Nm
Ambient Temperature	-25C. 80 C. (-40C. for -FZ versions).
Vibration resistance	10-500Hz 0.35mm
Shock resistance	15g 11ms
Tension Force (typical mid setting)	130N.
Typical Operating Force (Rope pulled)	< 125N. < 300mm Deflection
Approx. Weight	GLHD-SS 2200g. GLHL / R-SS 2000g. GLHD 1320g. GLHL / R 1100g. GLS 880g. GLS-SS 1635g. GLM 675g.

Electrical:

Safety Contact type	IEC 60947-5-1 Double break Type Zb
Contact Material	Silver
Termination	Clamp up to 2.5 sq. mm conductors
Rating	Utilisation Category : AC15
Operational Rating	AC15 A300 240V. 3A /120V 6A. ac 24V. 2.5A dc inductive
Thermal Current (Ith)	10A
Rated Insulation Voltage (Ui)	500V.
Withstand Voltage (Uimp)	2500V.
Short Circuit Overload Protection	Fuse Externally 10A. (FF)

Optional Explosion Proof Contact Block

Type	IDEM LS-Ex
EC Type Certificate Number	Baseefa11ATEX0267X
IEC Certificate Number	IECEx BAS11.0133X
Classification	Ex d IIC T6 (-20C Ta 60C) Gb Ex tb IIIC T85C (-20C Ta 60C) Db
Zones	1, 21, 2, 22
Rated Voltage	250V ac/dc
Rated Current	2 pole 4A. 4 pole 2.5A.

Optional AS-I Safe versions M12

Operation / Fault / Function	Green / Yellow / Red
AS-interface / extended cross mode possible	Version 2.1 / no S-7.B.E
AS-I profile	
I/O configuration / ID code	7(Hex) / B.E(Hex)

Safety Classification and Reliability Data:

Mechanical Reliability B10d	1.5 x 10 ⁶ operations at 100mA load
EN 954-1	up to Category 4 with Safety Relay
ISO 13849-1	up to PLe depending upon system architecture
EN 62061	up to SIL3 depending upon system architecture
Safety Data - Annual Usage	8 cycles per hour / 24 hours per day / 365 days
PFHd	<1.0 x 10 ⁻⁷
Proof Test Interval (Life)	21 years
MTTFd	214 years

Information with regard to UL 508:

Type 1 Enclosures.
Control Number 35NV.
Use 16 - 12AWG copper conductors, rated 90°C minimum.
Intended for same polarity use and one polymeric conduit connection.
Electrical Rating:
Max. Switching Current / Volt / Amp:
120V. 6A. (720VA break) PF 0.38
240V. 3A. (720VA break) PF 0.38

Information with regard to AS1755 .2000: Clause 2.7.9.1:

1. Perpendicular Force to operate the switches midway between Eyebolt Supports:
Check <70N. Rope Deflection <300mm

2. Axial Force - Direct along rope axis: <230N. (Typical 125N).

Wiring circuits for Explosion Proof Versions:

1 NC 1 NO

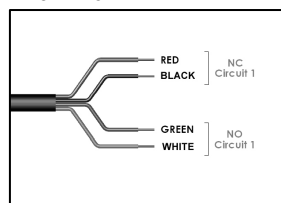

2 NC 2 NO

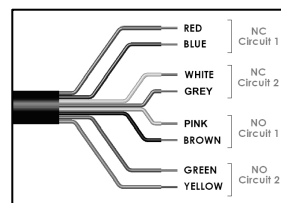

2 NC

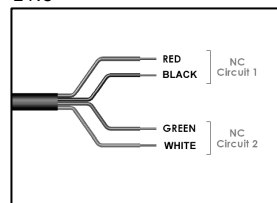

Safety Rope Switches from IDEM

11. Dimensions

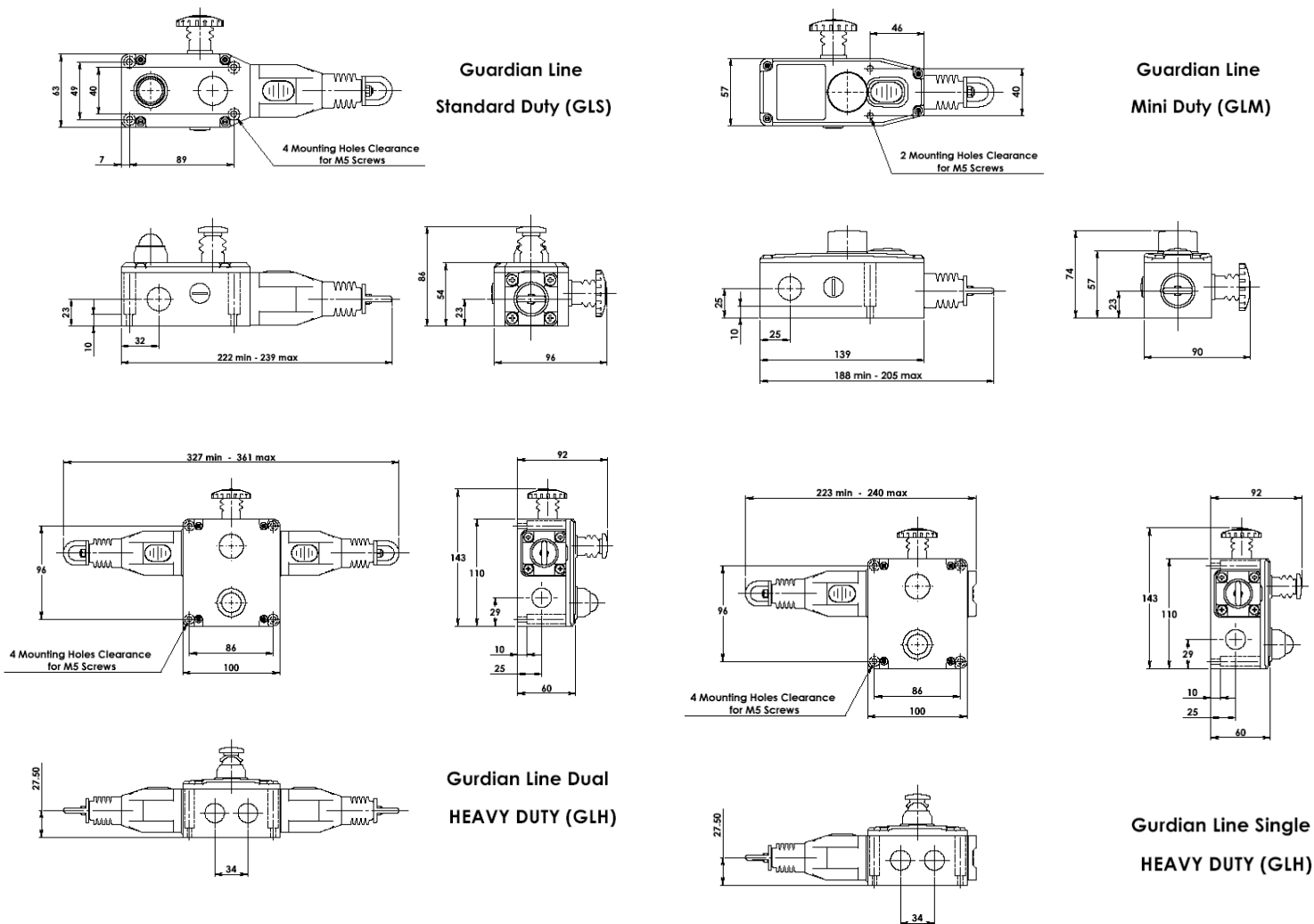

12. Accessories

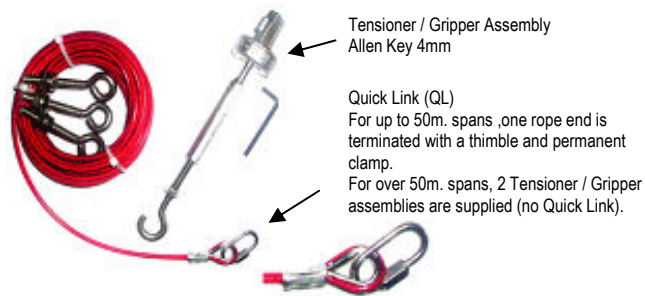

Sales Number		Description	Rope	Eyebolts	Tensioner Gripper S/S	Allen Key
Galvanised	Stainless Steel					
140001	140010	5M Rope Kit	5M QL	3	1	1
140002	140011	10M Rope Kit	10M. QL	5	1	1
140003	140012	15M Rope Kit	15M. QL	7	1	1
140004	140013	20M Rope Kit	20M. QL	9	1	1
140005	140014	30M Rope Kit	30M. QL	12	1	1
140006	140015	50M Rope Kit	50M. QL	20	1	1
140007	140016	80M Rope Kit	80M.	30	2	2
140008	140017	100M Rope Kit	100M.	37	2	2
140009	140018	125M Rope Kit	126M.	45	2	2
140033		Rope only 5M				
140034		Rope only 10M				
140036		Rope only 20M				
140037		Rope only 30M				
140038		Rope only 50M				
140039		Rope only 80M				
140040		Rope only 100M				
140041		Rope only 126M				

Sales Number		Description	
140019 140020		Rope Tensioner / Gripper	Stainless Steel Galvanised Steel
140021 140064		77mm Long 40mm High Fixing Hole centres 20mm	Universal Pulley Stainless Steel Universal Pulley Galvanised
140045 140046		84mm Long Thread length 51mm M8 x 1.25	Eyebolt Stainless Steel Eyebolt Galvanised
Standard Bezel	S/Steel Bezel	140042-A 140042-B 140042-C 140132-AS 140132-BS 140132-CS	LED Green / Flashing Red 24V.dc. LED Green / Flashing Red 110-120V.ac. LED Green / Flashing Red 230V.ac. LED Steady Green/Steady Red 24V.dc. LED Steady Green/Steady Red 110-120V.ac. LED Steady Green/Steady Red 230V.ac.
140044 140144		E-Stop Mechanism – Standard E-Stop Mechanism – Stainless Steel	
140043		Safety Spring	220mm long

